

RA1-S



RA2-S



RA1-F



RA2-F



ЦИРКУЛЯЦИОННЫЕ НАСОСЫ

Серия RA - трёхскоростные циркуляционные насосы с мокрым ротором предназначены для циркуляции холодной и горячей воды в системах отопления и охлаждения, вентиляции и кондиционирования воздуха. Не допускается установка и эксплуатация насоса в взрывоопасных зонах, для перекачивания легковоспламеняющихся и взрывчатых веществ.

Используются в жилых помещениях и на промышленных объектах. Бесшумные, потребляют мало электроэнергии.

Технические данные	RA1-S	RA2-S	RA1-F	RA2-F
Подача, м ³ /час	9,5 м ³ /час	14,4 м ³ /час	75 м ³ /час	120 м ³ /час
Напор, м	12 м	10,8 м	12 м	12 м
Потребляемая мощность, P ₁	260 Вт	509 Вт	2460 Вт	2200 Вт
Исполнение по току: напряжение / частота	однофазное: 1~230 В / 50Гц трёхфазное: 3~400 В / 50Гц			
Степень защиты / класс изоляции	IP 44 / F		IP 43 / F	
Режим работы мотора	S1			
Встроенная тепловая защита	в однофазных моделях		отсутствует	
Вязкость воды	до 10 cSt (мм ² /с)			
Охлаждение мотора	внутреннее за счёт перекачиваемой среды			
Температура перекачиваемой жидкости	от -10 ⁰ до +110 ⁰ С		от -10 ⁰ до +120 ⁰ С	
Температура окружающей среды, max	35 ⁰ С (не должна быть ниже температуры замерзания перекачиваемой среды)			
Давление в системе, max	6 / 10 bar			
Количество скоростей	3-х скоростные			
Материалы				
Корпуса насоса	чугун			
Рабочие колеса	нерж. сталь AISI 316			
Вал	нерж. сталь AISI 420			
Тип уплотнения вала, материалы	графит / оксид алюминия			
Резьбовые соединения	чугун (в комплект не входят)			

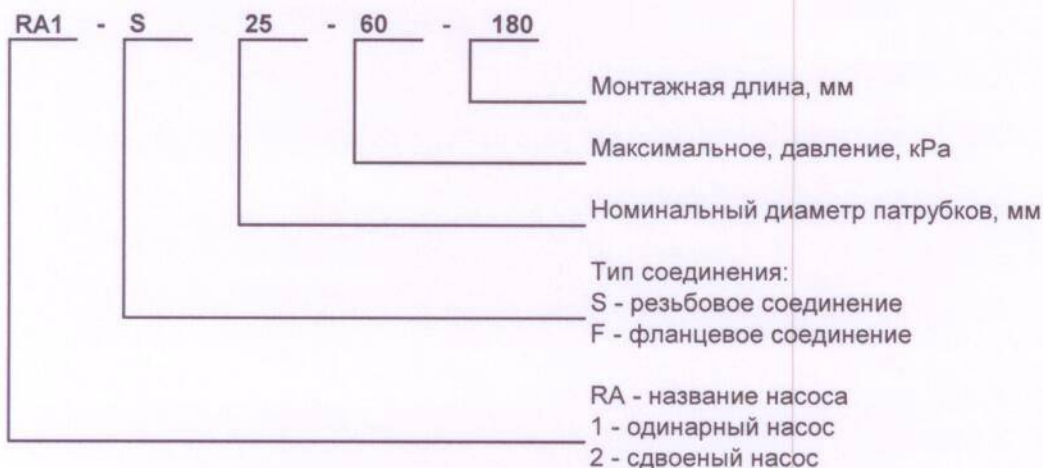

Характеристики серии RA1 -S, (1~230 В, L=130, L=180)

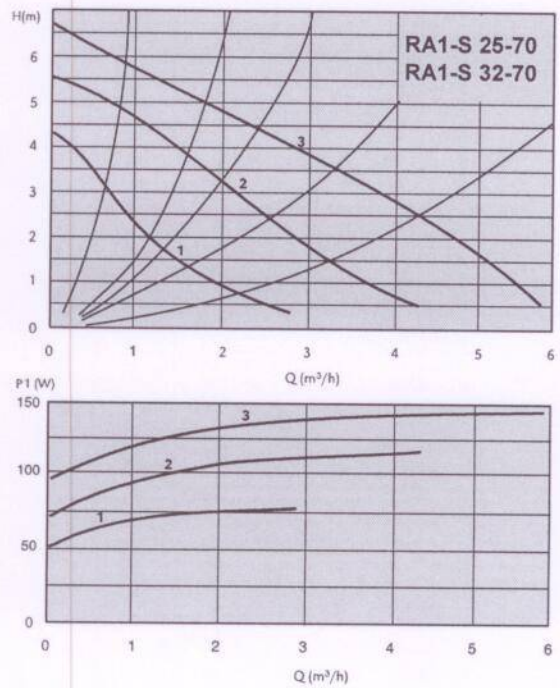
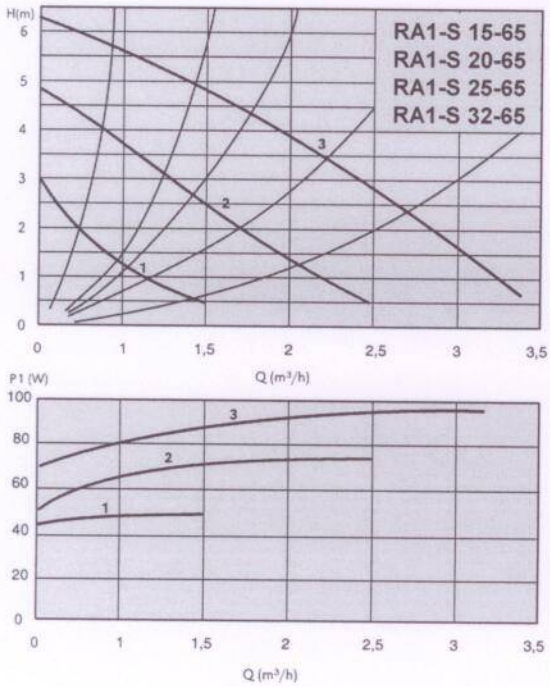
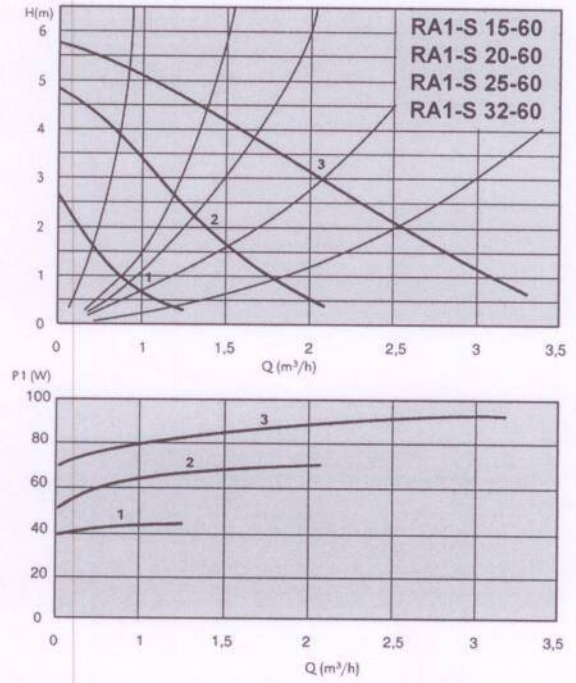
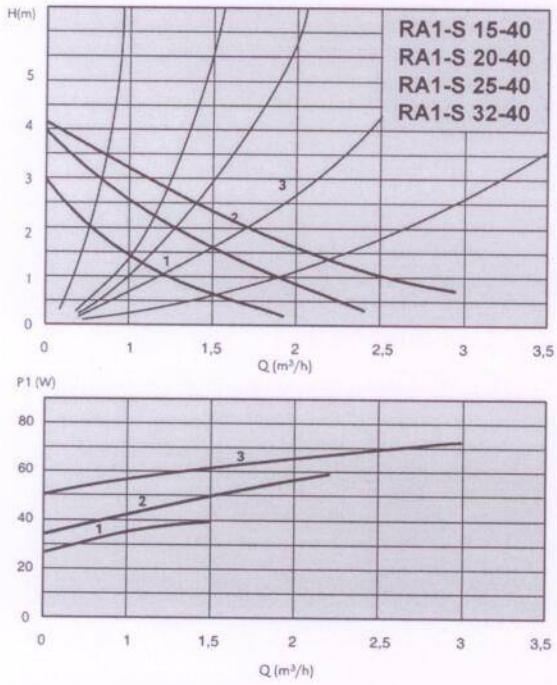

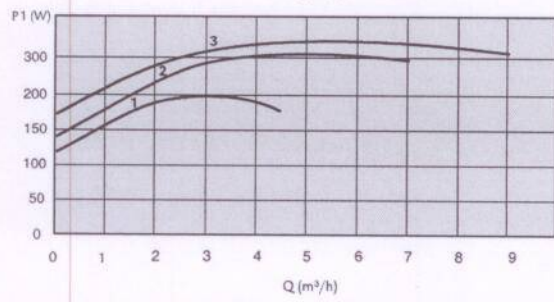
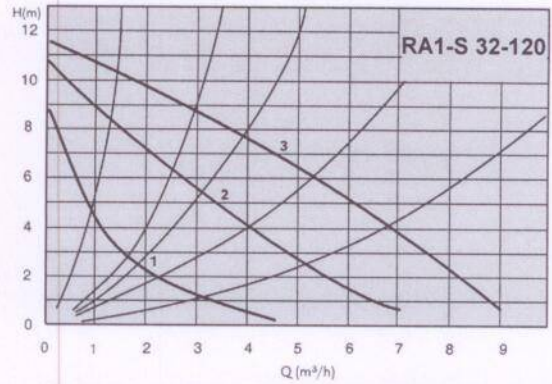
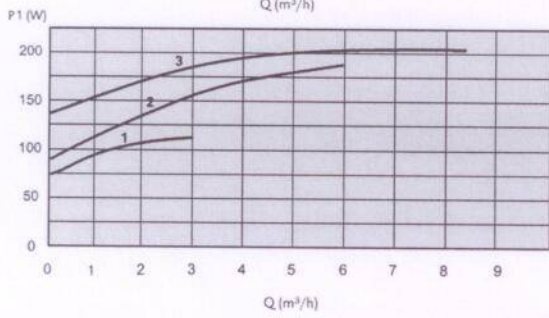
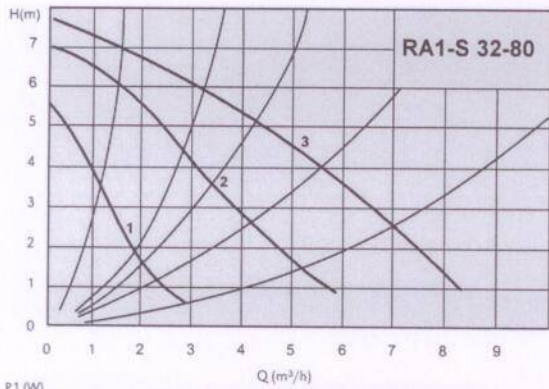

Характеристики серии RA2-S (1~230 В, L=180)

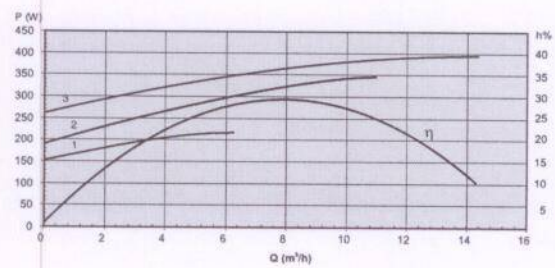
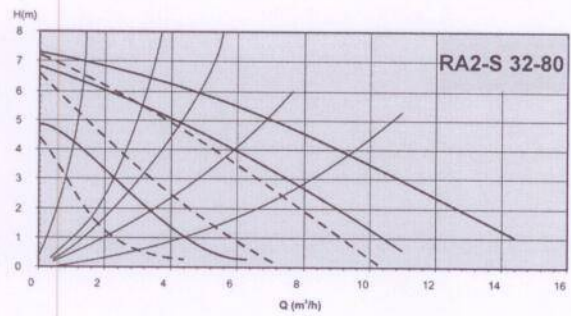
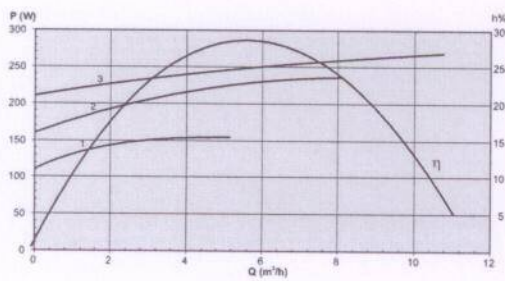
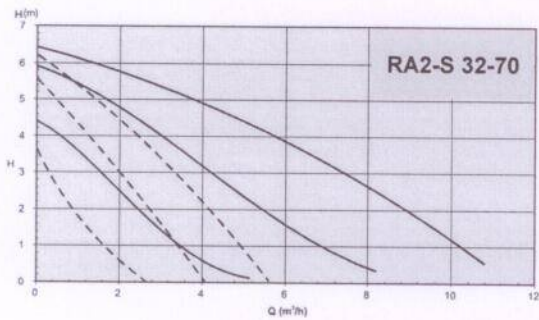

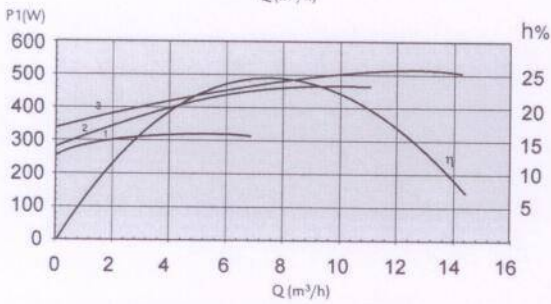
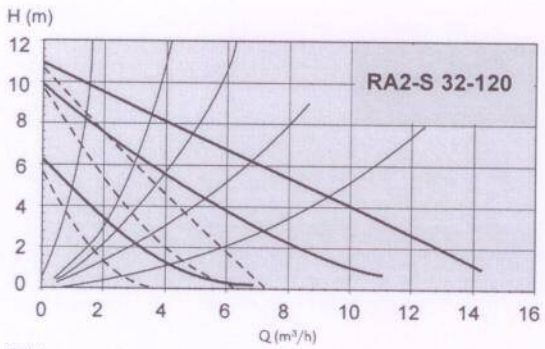

Характеристики серии RA1-F (3~400 В)

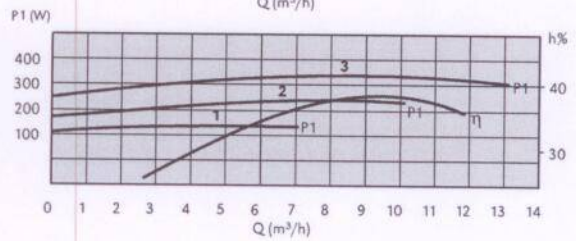
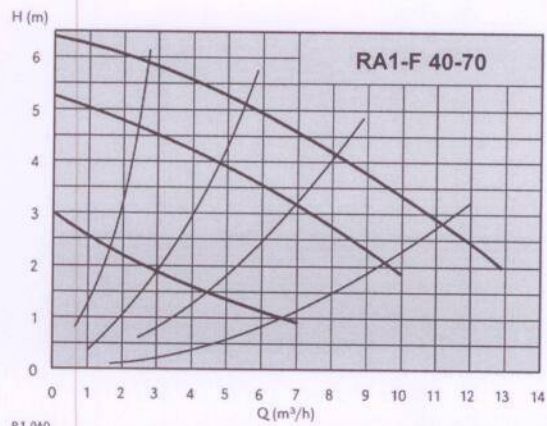
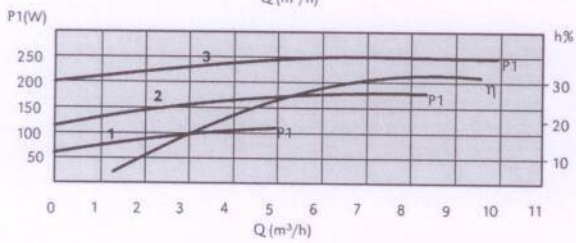
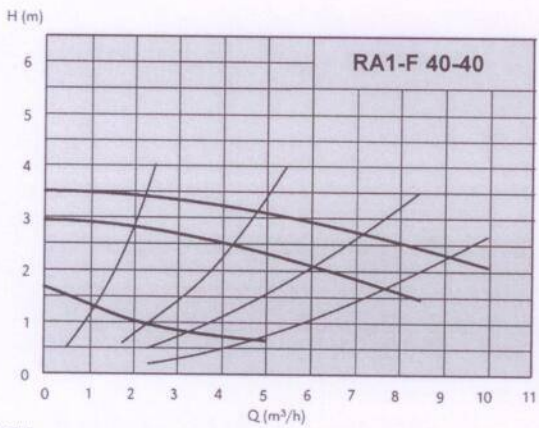

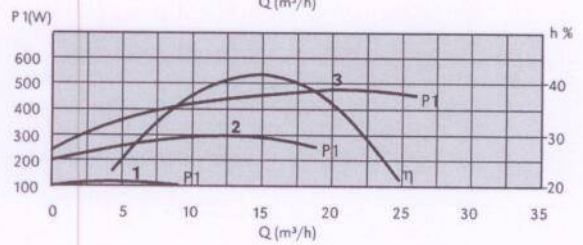
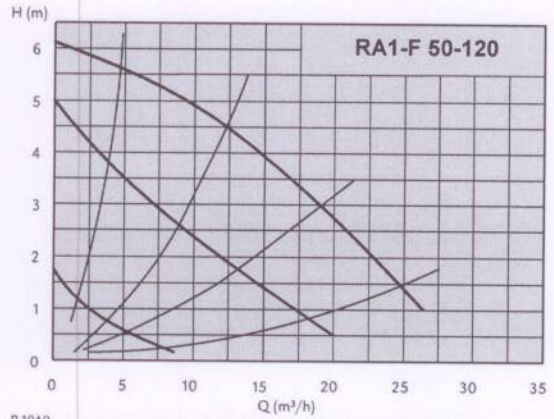
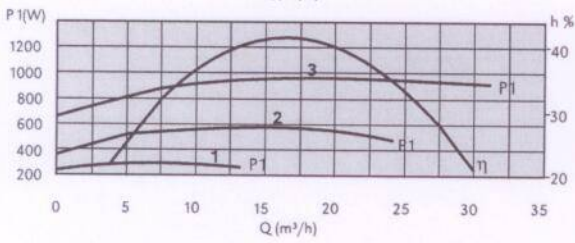
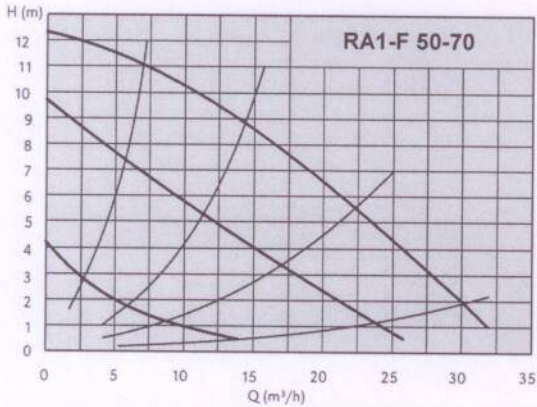
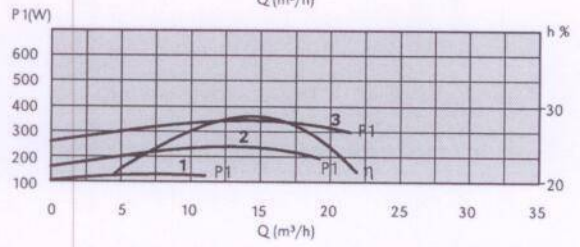
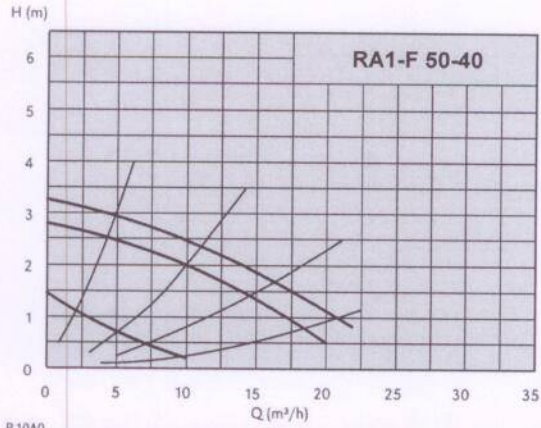
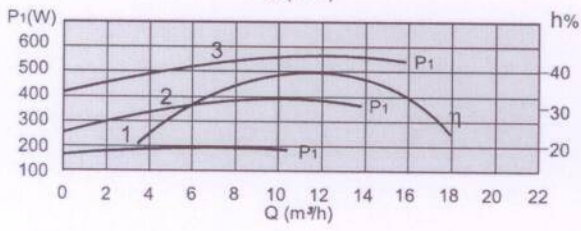
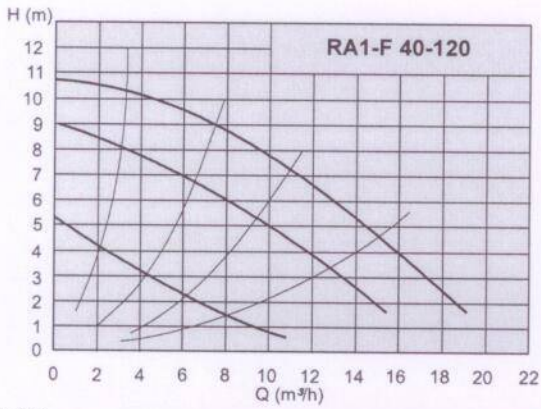

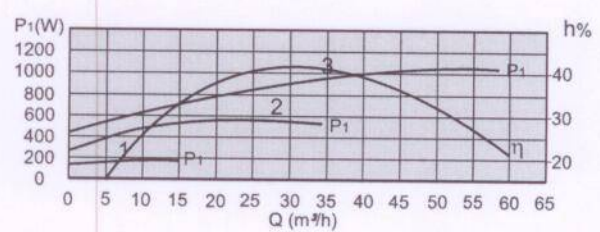
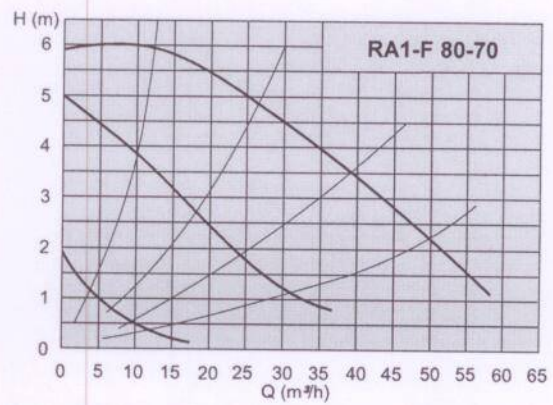
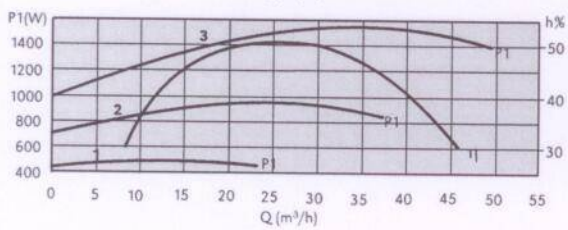
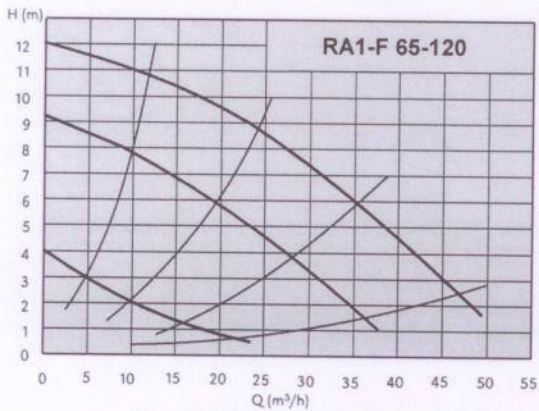
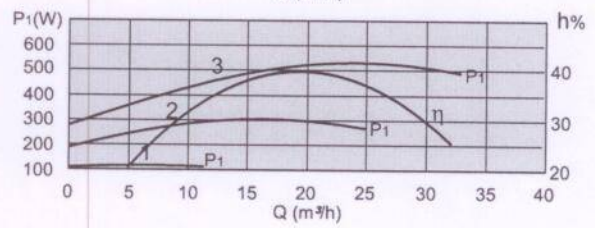
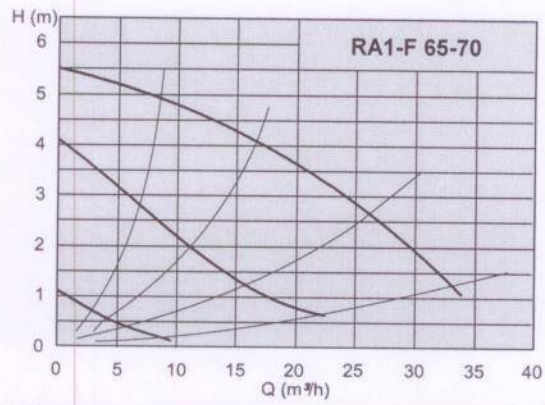
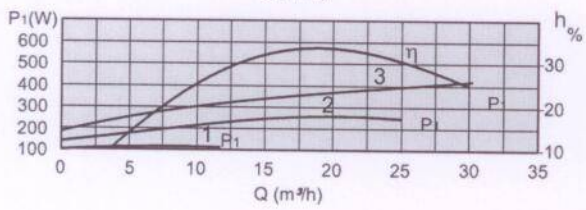
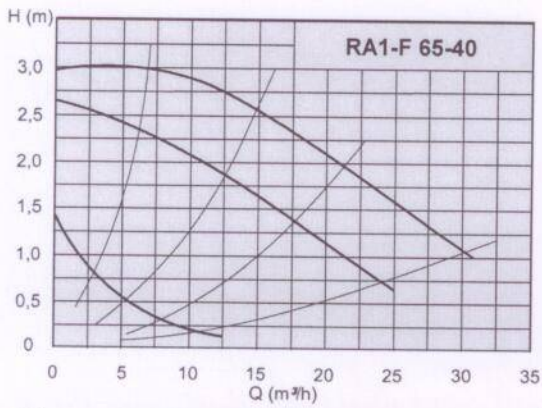

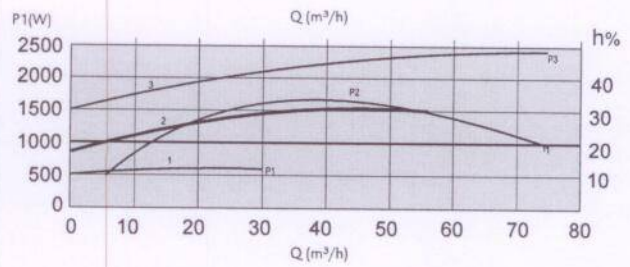
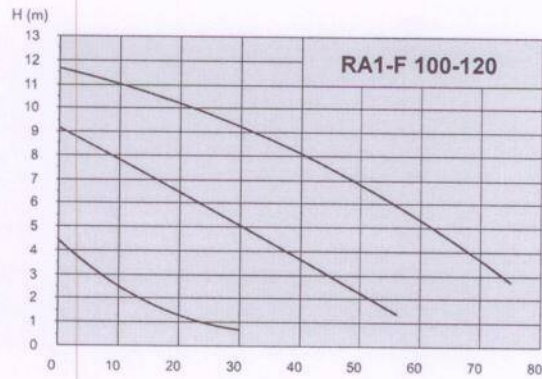
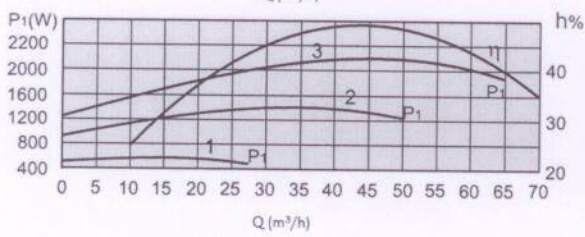
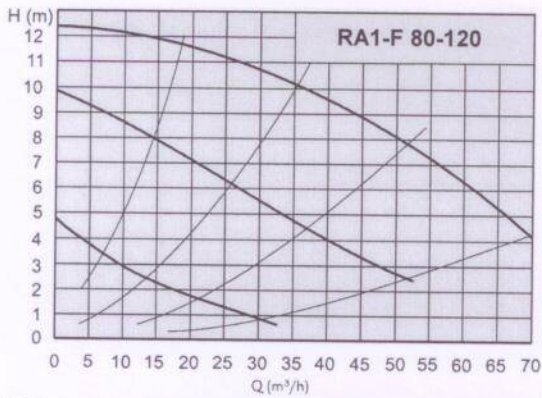

Характеристики серии RA2-F (3~400 В)

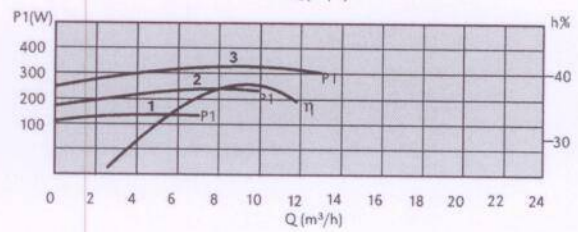
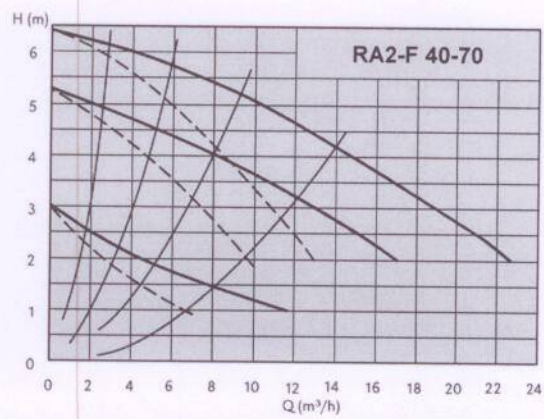
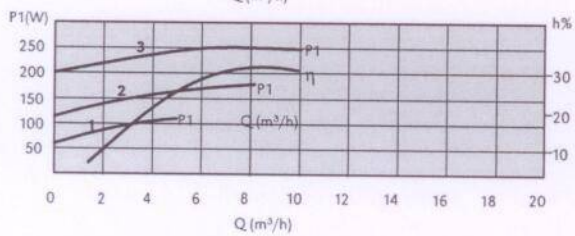
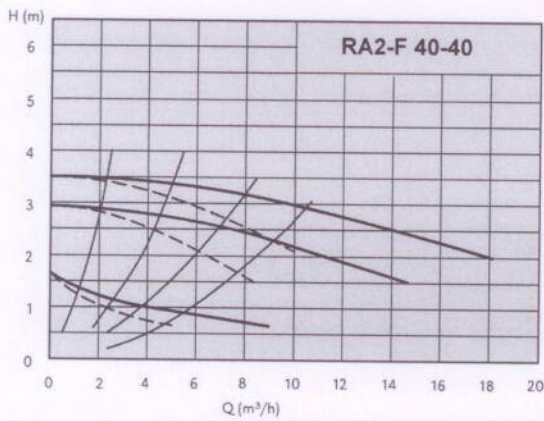

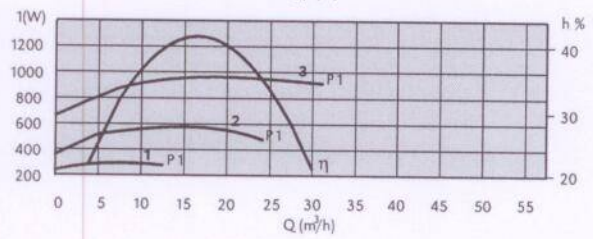
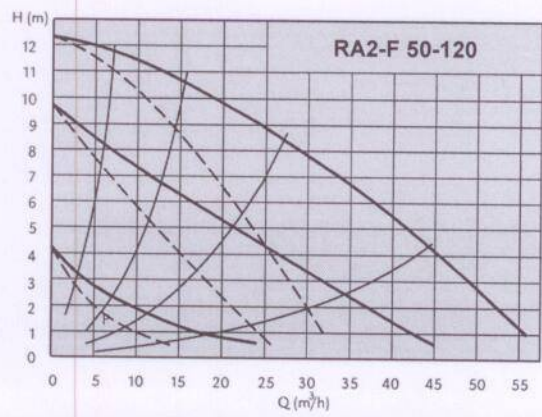
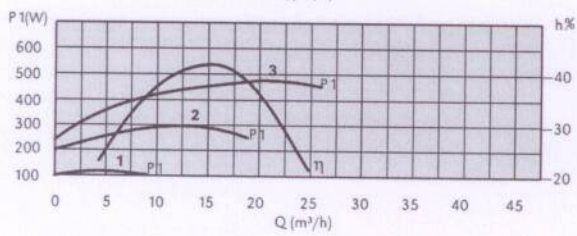
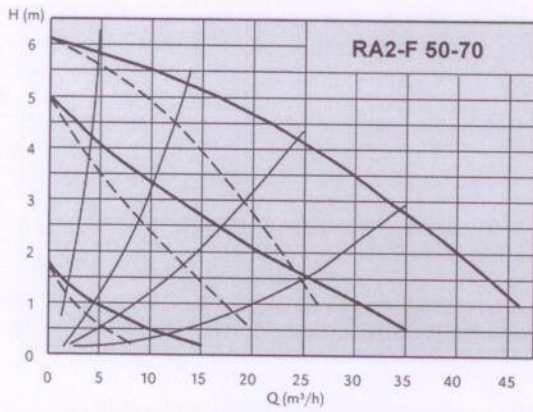
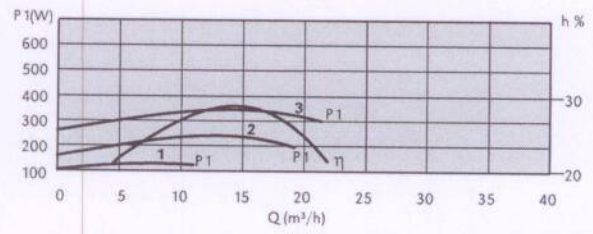
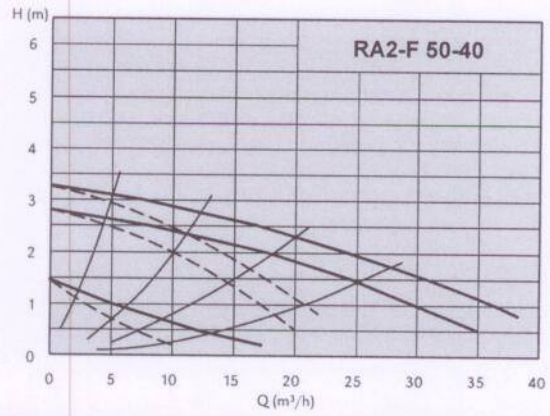
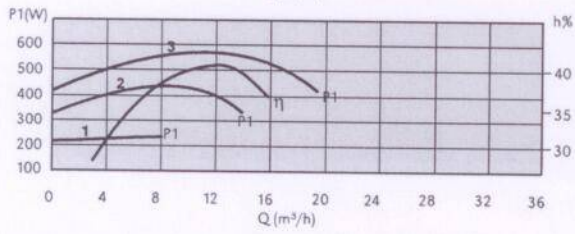
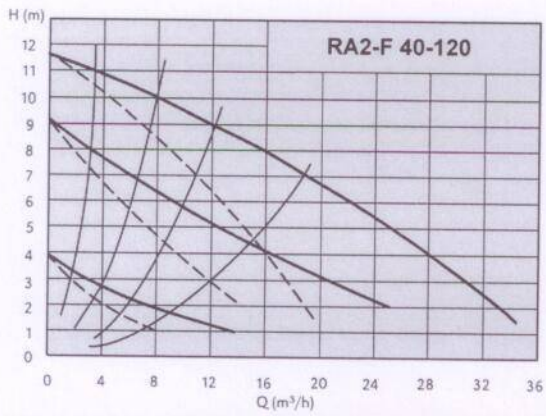

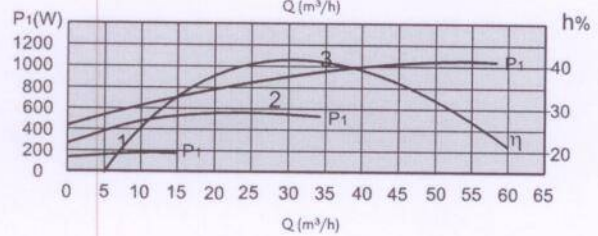
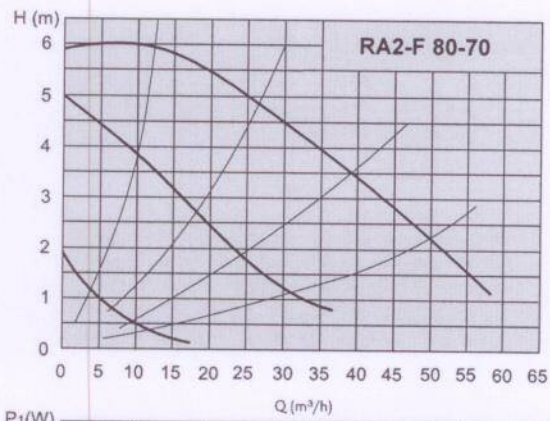
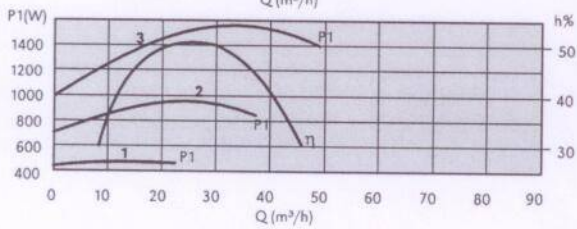
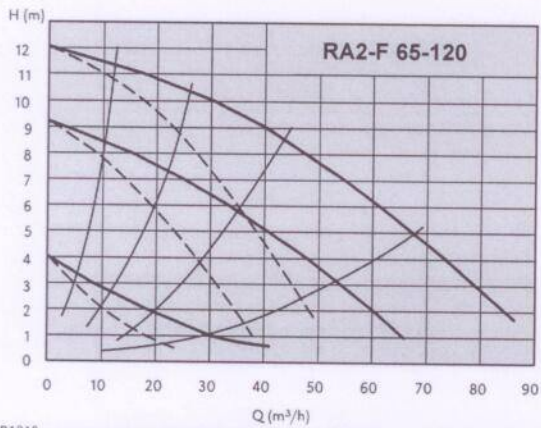
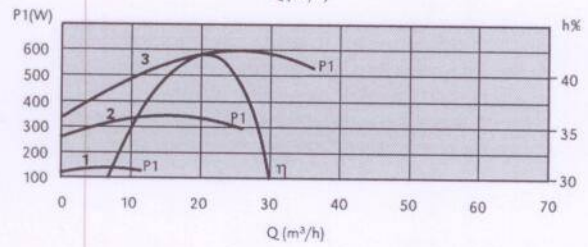
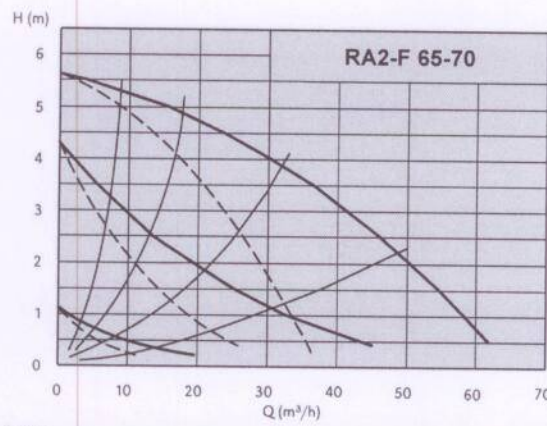
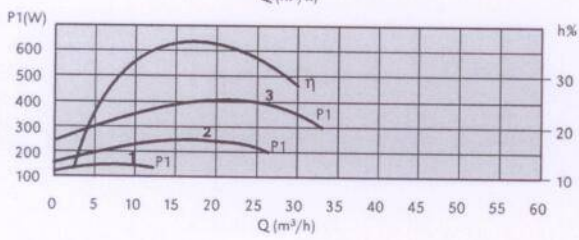
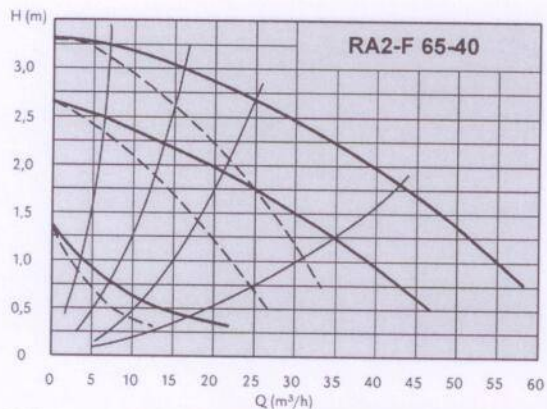

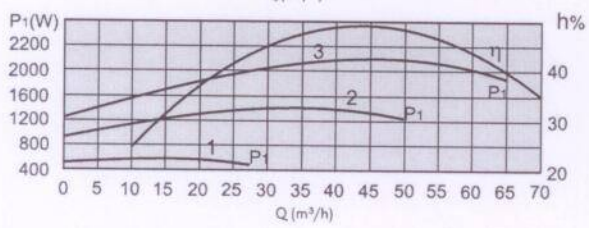
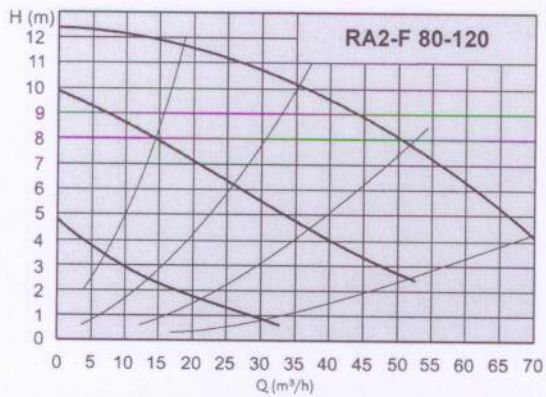

Разрешённые варианты монтажа

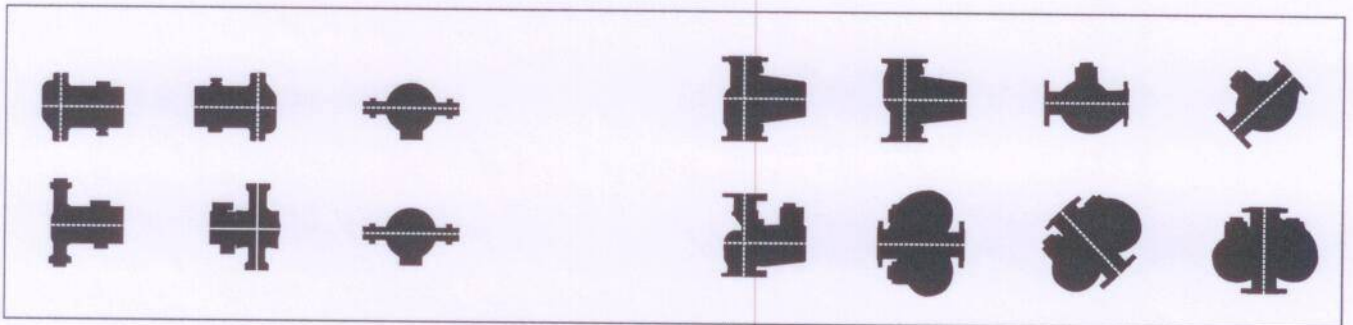

Размеры и вес

Тип	Артикул	Вольт	Подача м3/куб тах	Напор м. тах	Мощность, P1 (Вт)	Ток, А	Обороты двигателя	Давление в системе, bar	Рекомендуемое давление в системе, bar		
									Температура		
									50°C	80°C	100°C
ESPA RA1-S (одинарные)											
RA1-S 15-40-130	979521960	230	3,5	4	50	0,17-0,23	1315-2456	PN 10	0,05	0,4	1,1
RA1-S 15-60-130	979521961	230	3,5	6	90	0,17-0,39	1080-1980	PN 10	0,05	0,4	1,1
RA1-S 15-65-130	979521962	230	4	6,5	95	0,19-0,44	1080-1980	PN 10	0,05	0,4	1,1
RA1-S 20-40-130	979521700	230	3,5	4	50	0,17-0,23	1315-2456	PN 10	0,05	0,4	1,1
RA1-S 20-40-180	979521709	230	3,5	4	50	0,17-0,23	1315-2456	PN 10	0,05	0,4	1,1
RA1-S 20-60-130	979521702	230	3,5	6	90	0,17-0,39	1080-1980	PN 10	0,05	0,4	1,1
RA1-S 20-60-180	979521712	230	3,5	6	90	0,17-0,39	1080-1980	PN 10	0,05	0,4	1,1
RA1-S 20-65-130	979521706	230	4	6,5	95	0,19-0,44	1080-1980	PN 10	0,05	0,4	1,1
RA1-S 25-40-130	979521701	230	3,5	4	50	0,17-0,23	1315-2456	PN 10	0,05	0,4	1,1
RA1-S 25-40-180	979521710	230	3,5	4	50	0,17-0,23	1315-2456	PN 10	0,05	0,4	1,1
RA1-S 25-60-130	979521703	230	3,5	6	90	0,17-0,39	1080-1980	PN 10	0,05	0,4	1,1
RA1-S 25-60-180	979521713	230	3,5	6	90	0,17-0,39	1080-1980	PN 10	0,05	0,4	1,1
RA1-S 25-65-130	979521707	230	4	6,5	95	0,19-0,44	1080-1980	PN 10	0,05	0,4	1,1
RA1-S 25-65-180	979521704	230	4	6,5	95	0,19-0,44	1080-1980	PN 10	0,05	0,4	1,1
RA1-S 25-70-180	979521987	230	6	6,8	140	0,39-0,62	1109-2340	PN 10	0,05	0,4	1,1
RA1-S 32-40-180	979521711	230	3,5	4	50	0,17-0,23	1315-2456	PN 10	0,05	0,4	1,1
RA1-S 32-60-180	979521714	230	3,5	6	90	0,17-0,39	1080-1980	PN 10	0,05	0,4	1,1
RA1-S 32-65-180	979521705	230	4	6,5	95	0,19-0,44	1080-1980	PN 10	0,05	0,4	1,1
RA1-S 32-70-180	979521983	230	6	6,8	140	0,39-0,62	1109-2340	PN 10	0,05	0,4	1,1
RA1-S 32-80-180	979521944	230	8,4	8	210	0,46-0,91	1150-2450	PN 10	0,05	0,4	1,1
RA1-S 32-120-180	979522005	230	9,5	12	260	0,75-1,15	1150-2450	PN 10	0,05	0,4	1,1
ESPA RA2-S (сдвоенные)											
RA2-S 32-70-180	979522021	230	10,8	6,4	270	0,39-0,62	1109-2340	PN 10	0,05	0,4	1,1
RA2-S 32-80-180	979522022	230	14,4	7,3	393	0,49-0,95	1150-2450	PN 10	0,05	0,4	1,1
RA2-S 32-120-180	979522023	230	14,3	10,8	509	0,85-1,15	1150-2450	PN 10	0,05	0,4	1,1
ESPA RA1-F (одинарные)											
RA1-F 40-40	979521448	400	10	3,5	200	0,11-0,7	660-1440	PN 6 / 10	0,05	0,8	1,4
RA1-F 40-70	979521447	400	13	6	320	0,22-0,75	1440-2790	PN 6 / 10	0,05	0,8	1,4
RA1-F 40-120	979521446	400	20	12	580	0,34-1,45	1250-2820	PN 6 / 10	0,05	0,8	1,4
RA1-F 50-40	979521510	400	20	3,5	270	0,21-1,0	620-1450	PN 6 / 10	0,3	1	1,6
RA1-F 50-70	979521509	400	25	6	470	0,2-1,15	560-1400	PN 6 / 10	0,3	1	1,6
RA1-F 50-120	979521508	400	30	12	1060	0,46-1,73	1270-2800	PN 6 / 10	0,3	1	1,6
RA1-F 65-40	979521472	400	33	3,5	360	0,22-1,1	600-1430	PN 6 / 10	0,3	1	1,6
RA1-F 65-70	979521471	400	35	6	520	0,22-1,2	450-1370	PN 6 / 10	0,3	1	1,6
RA1-F 65-120	979521470	400	50	12	1640	0,84-2,9	1250-2810	PN 6 / 10	0,3	1	1,6
RA1-F 80-70	979521483	400	70	12	1030	0,42-2,2	600-1350	PN 10	0,3	1	1,6
RA1-F 80-70 (PN10)	979521497	400	60	6	960	0,42-2,2	600-1350	PN 6	0,3	1	1,6
RA1-F 80-120	979521482	400	70	12	2460	1,16-4,2	1200-2800	PN 6	0,3	1	1,6
RA1-F 80-120 (PN10)	979521496	400	70	12	2200	1,16-4,2	1200-2800	PN 6	0,3	1	1,6
RA1-F 100-120	979522755	400	75	11,5	2460			PN 10	0,3	1	1,6
ESPA RA 2-F (сдвоенные)											
RA2-F 40-40	979521454	400	18	3,5	240	0,11-0,70	660-1440	PN 6 / 10	0,05	0,8	1,4
RA2-F 40-70	979521453	400	22	6	320	0,22-0,75	1440-2790	PN 6 / 10	0,05	0,8	1,4
RA2-F 40-120	979521452	400	34	12	560	0,34-1,45	1250-2820	PN 6 / 10	0,05	0,8	1,4
RA2-F 50-40	979521466	400	38	3,5	340	0,21-1,0	620-1450	PN 6 / 10	0,3	1	1,6
RA2-F 50-70	979521465	400	45	6	470	0,2-1,15	560-1400	PN 6 / 10	0,3	1	1,6
RA2-F 50-120	979521464	400	55	12	950	0,46-1,73	1270-2800	PN 6 / 10	0,3	1	1,6
RA2-F 65-40	979521478	400	55	3,5	400	0,22-1,1	600-1430	PN 6 / 10	0,3	1	1,6
RA2-F 65-70	979521477	400	60	6	600	0,22-1,2	450-1370	PN 6 / 10	0,3	1	1,6
RA2-F 65-120	979521476	400	85	12	1560	0,84-2,9	1250-2810	PN 6 / 10	0,3	1	1,6
RA2-F 80-70	979521489	400	95	6	960	0,42-2,2	600-1350	PN 6	0,3	1	1,6
RA2-F 80-70 (PN10)	979521994	400	95	6	960	0,42-2,2	600-1350	PN 10	0,3	1	1,6
RA2-F 80-120	979521488	400	120	12	2200	1,16-4,2	1200-2800	PN 6	0,3	1	1,6
RA2-F 80-120 (PN10)	979521993	400	120	12	2200	1,16-4,2	1200-2800	PN 10	0,3	1	1,6

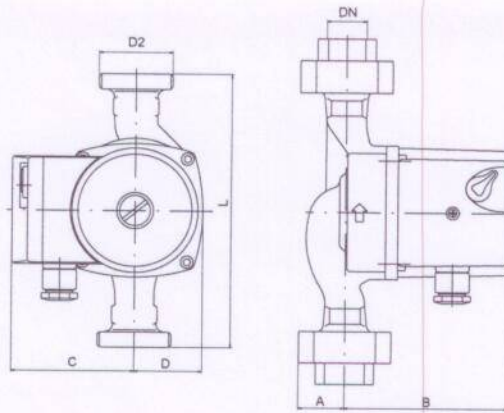

RA1-S

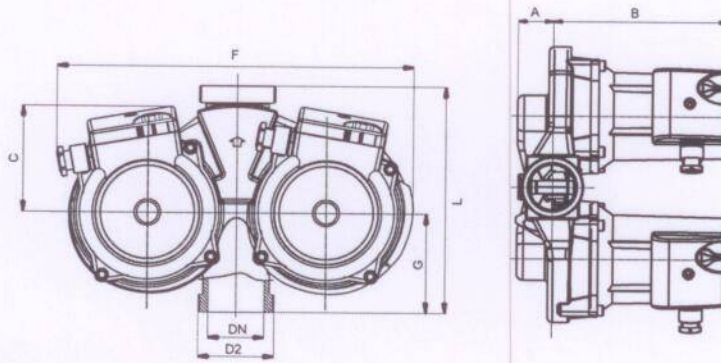

RA2-S

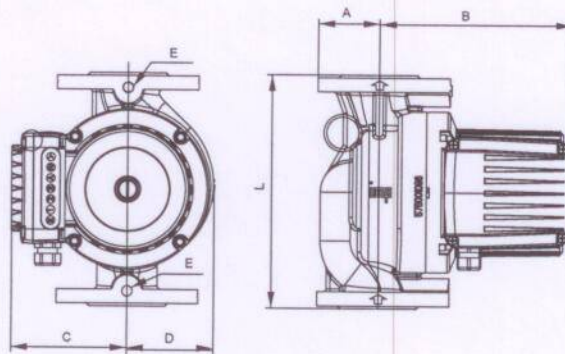

RA1-F

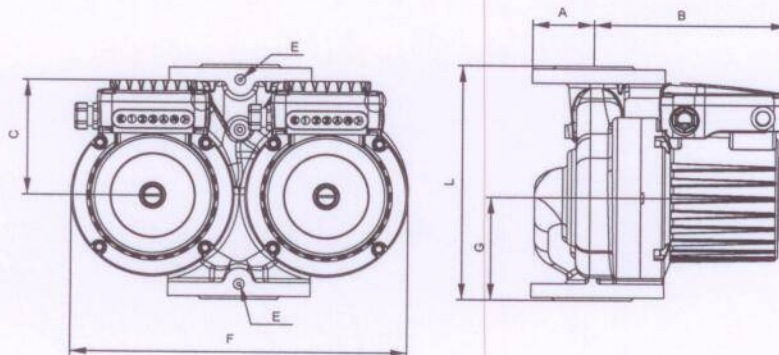

RA2-F

Размеры и вес

Тип	Артикул	Монтажная длина, L мм	D2	Размер соединения, DN	A	B	C	D	E	F	G	Вес
ESPA RA1-S (одинарные)												
RA1-S 15-40-130	979521960	130	G 1"	Rp 1/2"	28	108	80	44	-	-	-	2,2
RA1-S 15-60-130	979521961	130	G 1"	Rp 1/2"	28	108	80	44	-	-	-	2,2
RA1-S 15-65-130	979521962	130	G 1"	Rp 1/2"	28	108	80	44	-	-	-	2,2
RA1-S 20-40-130	979521700	130	G 1 1/4"	Rp 3/4"	28	108	80	44	-	-	-	2,4
RA1-S 20-40-180	979521709	180	G 1 1/4"	Rp 3/4"	28	108	80	44	-	-	-	2,4
RA1-S 20-60-130	979521702	130	G 1 1/4"	Rp 3/4"	28	108	80	44	-	-	-	2,4
RA1-S 20-60-180	979521712	180	G 1 1/4"	Rp 3/4"	28	108	80	44	-	-	-	2,6
RA1-S 20-65-130	979521706	130	G 1 1/4"	Rp 3/4"	28	108	80	44	-	-	-	2,2
RA1-S 25-40-130	979521701	130	G 1 1/2"	Rp 1"	28	108	80	44	-	-	-	2,4
RA1-S 25-40-180	979521710	180	G 1 1/2"	Rp 1"	28	108	80	44	-	-	-	2,6
RA1-S 25-60-130	979521703	130	G 1 1/2"	Rp 1"	28	108	80	44	-	-	-	2,4
RA1-S 25-60-180	979521713	180	G 1 1/2"	Rp 1"	28	108	80	44	-	-	-	2,6
RA1-S 25-65-130	979521707	130	G 1 1/2"	Rp 1"	28	108	80	44	-	-	-	2,4
RA1-S 25-65-180	979521704	180	G 1 1/2"	Rp 1"	28	108	80	44	-	-	-	2,4
RA1-S 25-70-180	979521987	180	G 1 1/2"	Rp 1"	30	108	80	44	-	-	-	3,2
RA1-S 32-40-180	979521711	180	G 2"	Rp 1 1/4"	30	108	80	44	-	-	-	3
RA1-S 32-60-180	979521714	180	G 2"	Rp 1 1/4"	30	108	80	44	-	-	-	3
RA1-S 32-65-180	979521705	180	G 2"	Rp 1 1/4"	30	108	80	44	-	-	-	3
RA1-S 32-70-180	979521983	180	G 2"	Rp 1 1/4"	30	108	80	44	-	-	-	3,2
RA1-S 32-80-180	979521944	180	G 2"	Rp 1 1/4"	31	173	80	67	-	-	-	4,8
RA1-S 32-120-180	979522005	180	G 2"	Rp 1 1/4"	31	150	80	57	-	-	-	5,6
ESPA RA2-S (сдвоенные)												
RA2-S 32-70-180	979522021	180	G 2"	Rp 1 1/4"	29	212	85	-	-	240	78	5,5
RA2-S 32-80-180	979522022	180	G 2"	Rp 1 1/4"	40	142	85	-	-	255	77,5	9,2
RA2-S 32-120-180	979522023	180	G 2"	Rp 1 1/4"	34	168	85	-	-	280	79	10
ESPA RA1-F (одинарные)												
RA1-F 40-40	979521448	250	DN 40	-	65	198	153	92	1/4"	-	-	18
RA1-F 40-70	979521447	250	DN 40	-	65	198	153	92	1/4"	-	-	19
RA1-F 40-120	979521446	250	DN 40	-	65	198	153	92	1/4"	-	-	20
RA1-F 50-40	979521510	280	DN 50	-	70	250	160	113	1/4"	-	-	23
RA1-F 50-70	979521509	280	DN 50	-	70	250	160	113	1/4"	-	-	25
RA1-F 50-120	979521508	280	DN 50	-	70	250	160	113	1/4"	-	-	25
RA1-F 65-40	979521472	340	DN 65	-	80	252	160	123	1/4"	-	-	30
RA1-F 65-70	979521471	340	DN 65	-	80	252	160	123	1/4"	-	-	30
RA1-F 65-120	979521470	340	DN 65	-	80	252	160	123	1/4"	-	-	31
RA1-F 80-70	979521483	360	DN 80	-	100	257	160	129,5	1/4"	-	-	36
RA1-F 80-70 (PN10)	979521497	360	DN 80	-	100	257	160	129,5	1/4"	-	-	36
RA1-F 80-120	979521482	360	DN 80	-	100	257	160	129,5	1/4"	-	-	37
RA1-F 80-120 (PN10)	979521496	360	DN 80	-	100	257	160	129,5	1/4"	-	-	37
RA1-F 100-120	979522755	360	DN 100	-	110	257	160	130	1/4"	-	-	37
ESPA RA 2-F (сдвоенные)												
RA2-F 40-40	979521454	250	DN 40	-	62	198	153		1/4"	346	110	34
RA2-F 40-70	979521453	250	DN 40	-	62	198	153		1/4"	346	110	35
RA2-F 40-120	979521452	250	DN 40	-	62	198	153		1/4"	346	110	35
RA2-F 50-40	979521466	280	DN 50	-	70	250	160		1/4"	400	121	44
RA2-F 50-70	979521465	280	DN 50	-	70	250	160		1/4"	400	121	46
RA2-F 50-120	979521464	280	DN 50	-	70	250	160		1/4"	400	121	47
RA2-F 65-40	979521478	340	DN 65	-	80	252	160		1/4"	450	141	49
RA2-F 65-70	979521477	340	DN 65	-	80	252	160		1/4"	450	141	52
RA2-F 65-120	979521476	340	DN 65	-	80	252	160		1/4"	450	141	56
RA2-F 80-70	979521489	360	DN 80	-	95	257	160		1/4"	470	146	57
RA2-F 80-70 (PN10)	979521994	360	DN 80	-	95	257	160		1/4"	470	146	57
RA2-F 80-120	979521488	360	DN 80	-	95	257	160		1/4"	470	146	60
RA2-F 80-120 (PN10)	979521993	360	DN 40	-	95	257	160		1/4"	470	146	60



www.agrovodcom.ru

- _____
- _____
- _____
- _____
- _____
- _____
- _____

